

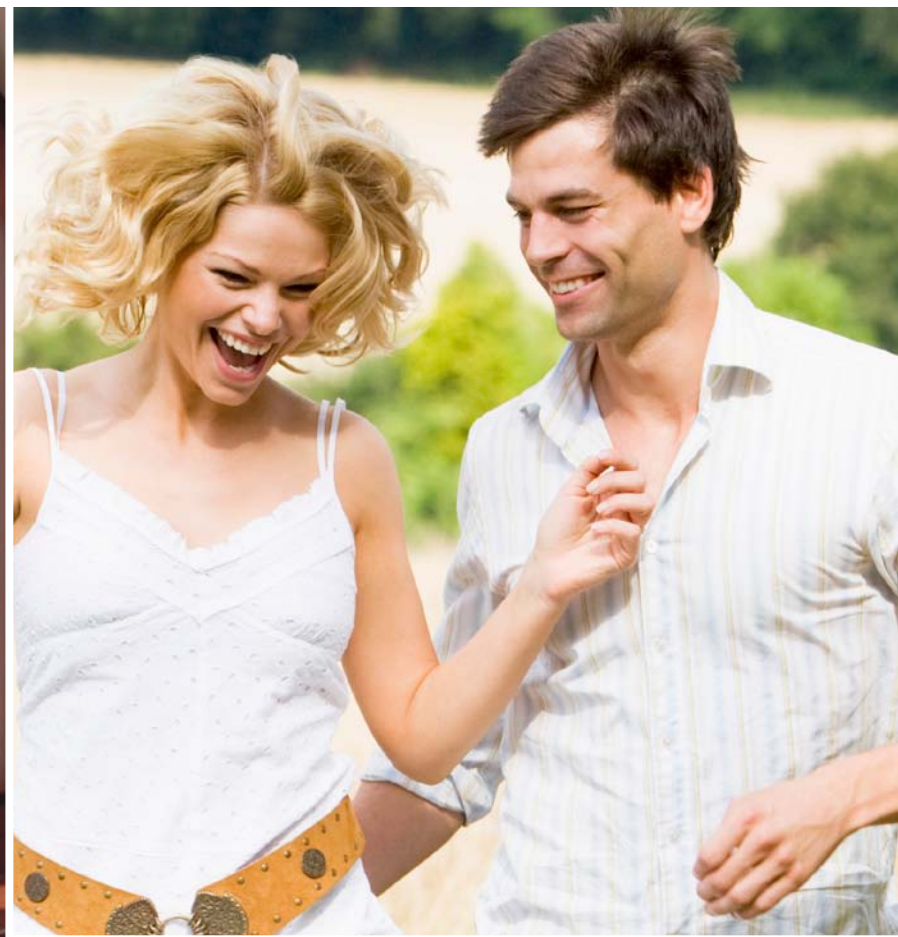

Product catalogue  
windows | doors | conservatories | façades



**BB** Windows & Doors  
**Bertrand**



# Tradition of Quality

**BB** Windows & Doors  
**Bertrand**

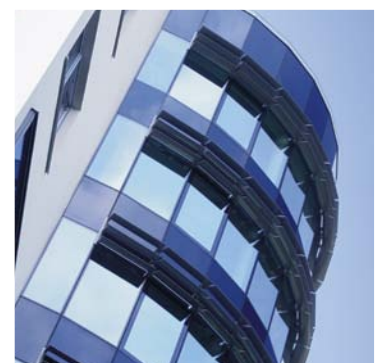

**Bertrand** is a renowned manufacturer of windows, doors, curtain walls and conservatories. The company was founded in 1969 and we have quenched the dreams of our numerous customers not only in Poland but in Europe and worldwide.

Our extensive range of products is characterised by an exceptional quality. We use manufacturing procedures based on modern technology and apply a wide range of materials: different types of wood, a variety of PVC and aluminium profile systems as well as combined materials, such as wood-aluminium or PVC-aluminium.

We provide a comprehensive service in every respect. Share your dreams with us and we'll make them come true. Your dream project is somewhat extraordinary? Great! Taking on challenges is what we do.

**Let's get together!**

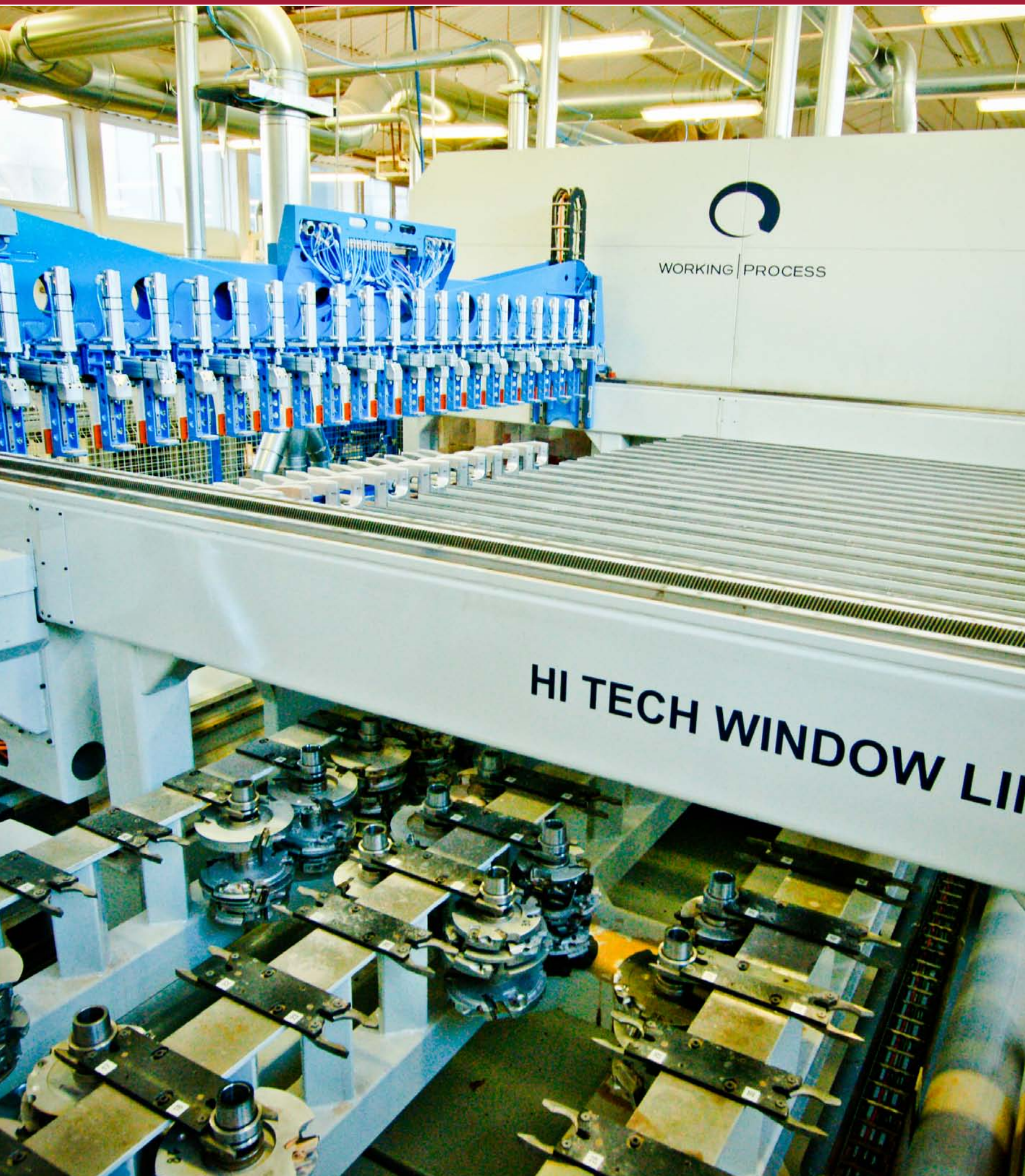



# Know-how

Bertrand has many years of experience in the tradition of fine craftsmanship. For many years we have been progressively implementing the most up-to-date technologies and modernising our machinery. Thanks to our state-of-the-art CNC equipment we are able to mass produce high quality goods at lower prices. We are proud of our highly professional staff who maintain a co-operative team spirit. Their wide knowledge, hands-on experience and sometimes artistry make it possible for us to fulfill our customers' special requirements so we are keen to take on any challenges.

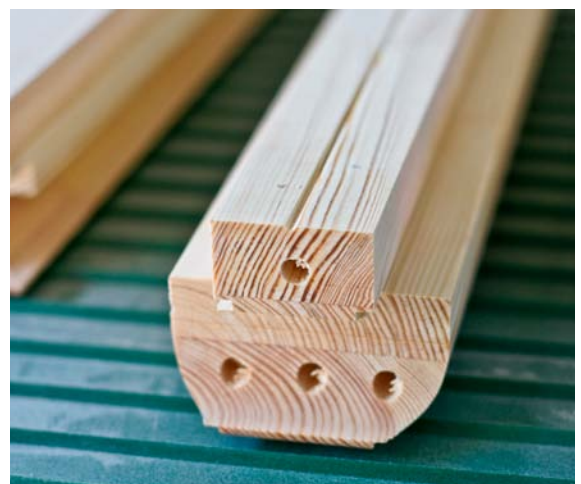
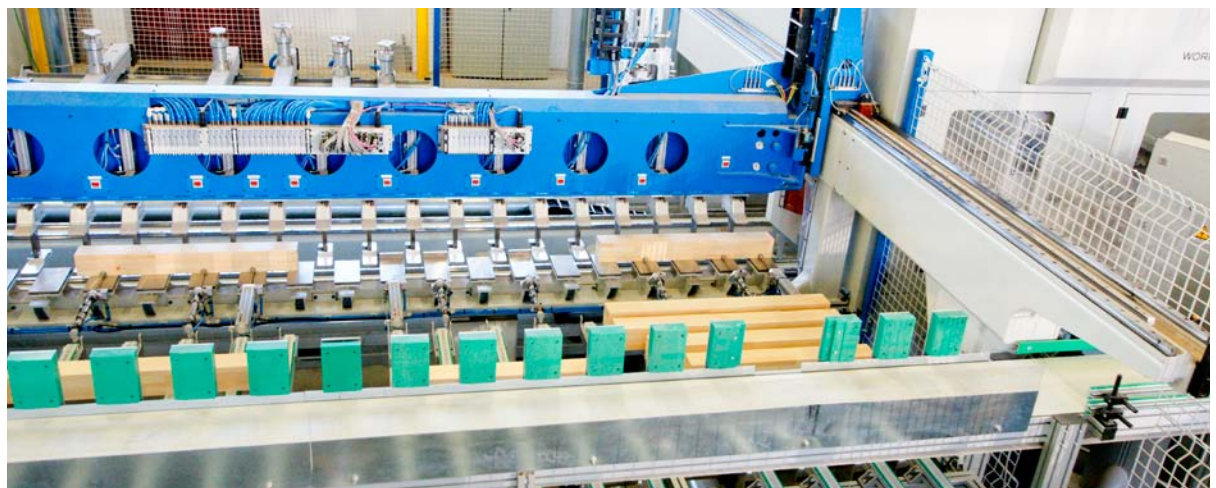





# Unlimited Imaginative Creativity



## Note

This catalogue contains a brief review of our product range. If you want to find out more about a certain product, ask for the more detailed catalogue of that product line or contact us.





# PVC windows



**PVC** or polyvinyl chloride is a modern all-purpose material. It is a very good material for windows. PVC window profile systems have been constantly perfected for many years and now they are of a very high level, allowing them to effectively compete with windows made of more traditional materials.

Bertrand PVC windows are characterised by their high quality and technological innovation. Customised products can be equipped with additional features to improve thermal or acoustic performance and security.





# Trend (XL)

PVC Windows



depth  
74 mm  
(XL-83 mm)



double or triple  
glazed units



thermal  
insulation



microventilation



durability



high  
quality





# Trend Alu-Vision

PVC-aluminium windows



innovation:  
PVC-ALU



depth  
93 mm



double or triple  
glazed units



thermal  
insulation



microventilation



durability



high  
quality





# Comfort

PVC Windows



depth  
74 mm



double or triple  
glazed units



burglar  
resistance



thermal  
insulation



microventilation



durability



high  
quality







# Comfort XL

PVC Windows



depth  
83 mm



double or triple  
glazed units



burglar  
resistance



thermal  
insulation



microventilation



durability



high  
quality





# Combisystem

PVC Windows



depth  
83 mm



double or triple  
glazed units



modern  
technology



thermal  
insulation



microventilation



durability



high  
quality





# Futura

PVC Windows

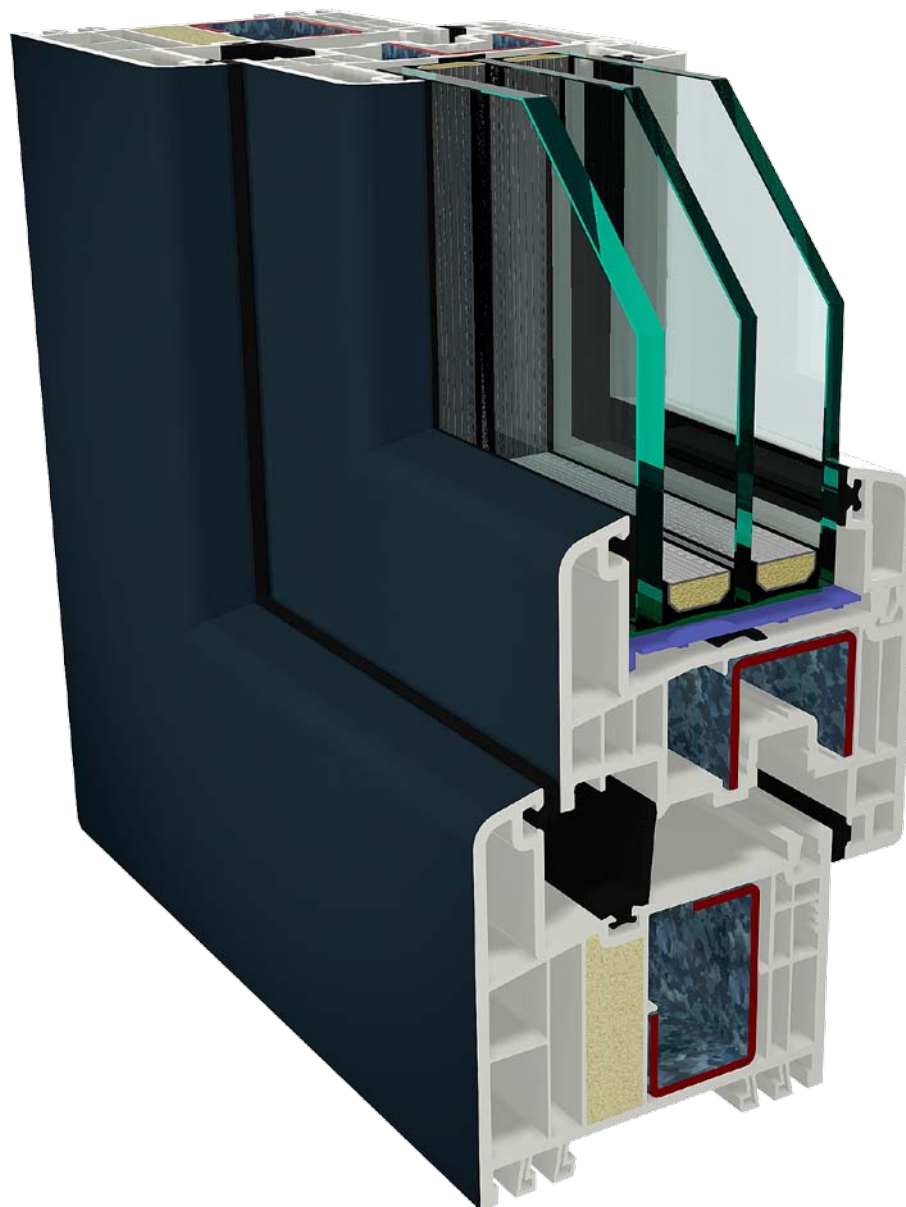

high heat insulation



depth 83 mm



triple glazed units



burglar resistance



modern technology



microventilation



durability



high quality



# Trend Slide

PVC Sliding Windows

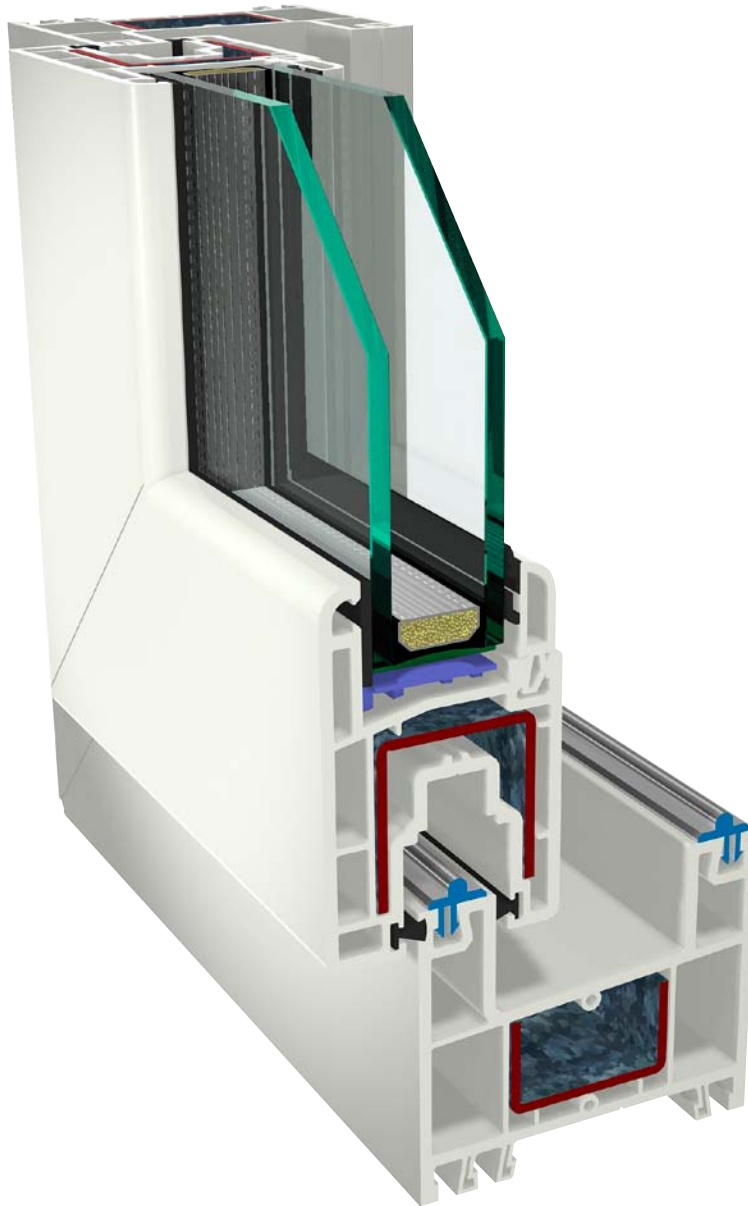

innovation:  
sliding  
window



depth  
74 mm



double glazed  
units



thermal  
insulation



acoustic  
insulation



durability



high  
quality



# Durable colours

PVC Windows

## Acrylcolor

**Acrylcolor: is not** a painted coating or a laminate - **is** a co-extrusion of two molten materials - **is** approximately 0.5mm thicker than a single layer of paint - **is** scratchproof and non-sensitive - **is** inseparably bonded with the profile - **is** resistant to flaking and chipping - **is** easy-care and low maintenance.

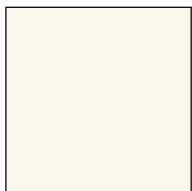

RAL 9001

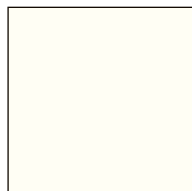

RAL 9010

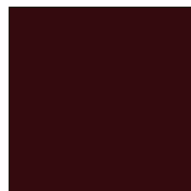

RAL 8022

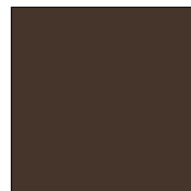

RAL 8014



RAL 3011

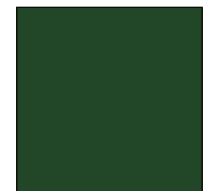

RAL 6005

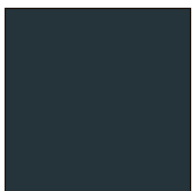

RAL 7016

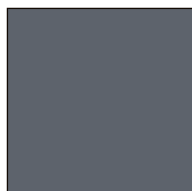

RAL 7015



RAL 7038



RAL 7040

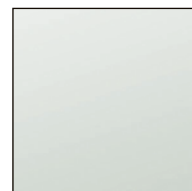

RAL 9006



Silver

## Wood-grain foils



1192001



137905

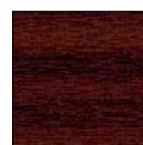

2065021



2178001



2178007

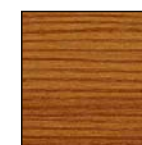

3069037

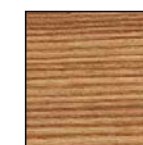

3069041



3118076

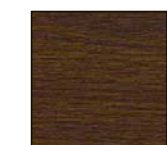

3149008



3162002

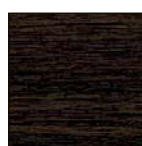

3167004



4252041



4252042

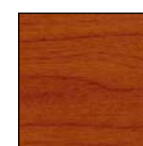

4252043

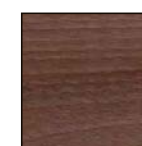

49233

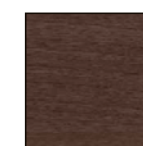

49237



49240-015

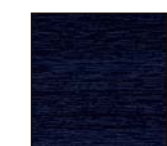

515005

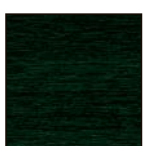

612505

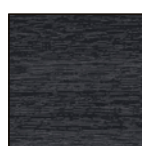

701605



715505



887505





# Timber windows

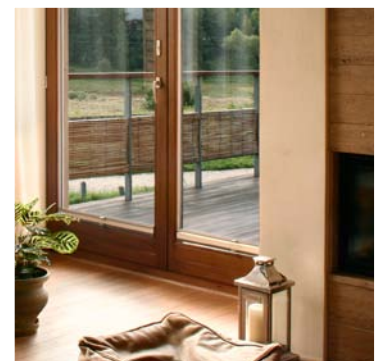
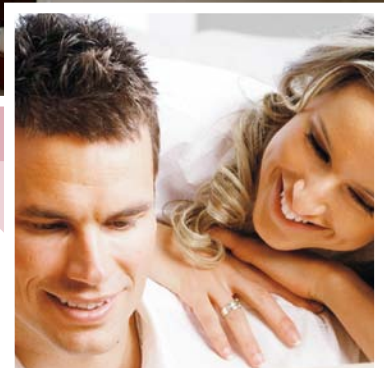
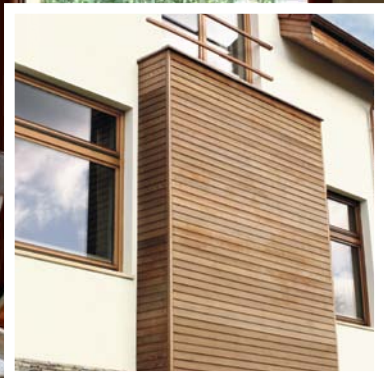

We aim to make you feel good in your own surroundings. We manufacture items made of natural materials. Timber for sure being within this category. The natural structure of timber is porous and fibrous, so products made from it are stable and durable. Wooden windows are characterised by their unique elegance and create a pleasant atmosphere and healthy climate. Through the use of modern timber processing technology, we bring out the main advantages of this material which results in highly durable and functional woodwork, ensuring the comfort and safety of its users.

Bertrand timber windows are characterised by their high quality and technological innovation. Customised products can be equipped with additional features to improve thermal or acoustic performance and security.





# Softline (XL) Elegant

Timber windows



depth  
68 mm  
(XL-78 mm)



double glazed  
units  
(XL-triple)



burglar  
resistance



soft, rounded  
shape



thermal  
insulation



microventilation



durability



high quality





# Softline (XL) Perfect

Timber windows



depth  
68 mm  
(XL-78 mm)



double glazed  
units  
(XL-triple)



burglar  
resistance

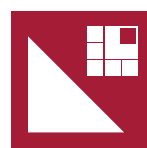

simple, modern  
design



thermal  
insulation



microventilation



durability



high  
quality





# Softline (XL) Prestige

Timber windows



depth  
68 mm  
(XL-78 mm)



double glazed  
units  
(XL-triple)



burglar  
resistance



classic design



thermal  
insulation



microventilation



durability



high  
quality







# Strongline Master

Timber windows



depth  
92 mm



triple glazed  
units



burglar  
resistance

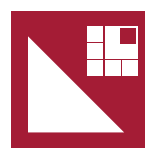

simple, modern  
design



thermal  
insulation



microventilation



durability



high  
quality





# Strongline Retro

Timber windows



depth  
92 mm



triple glazed  
units



burglar  
resistance



design  
classique



thermal  
insulation



microventilation



durability



high  
quality





# Thermoline

Timber windows



high heat  
insulation  
passive standard



depth  
92 mm



triple glazed  
units



burglar  
resistance

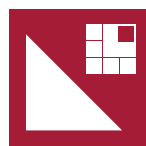

simple, modern  
design



microventilation



durability



high  
quality



# Thermoline XL

Timber windows



high heat insulation  
 passive standard



depth  
 112 mm



triple or  
 quadruple  
 glazed units



burglar  
 resistance

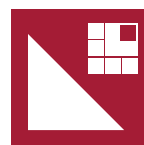

simple, modern  
 design



microventilation



durability



high  
 quality



# Colours

T i m b e r w i n d o w s

We have a wide colour palette for transparent timber finishes and can also finish timber in any standard RAL or NCS colour (non-transparent). Windows can also be ordered with alternative colours inside and outside or with individual components of varying colours. The use of transparent or semi-transparent finishes greatly enhances the natural beauty of timber.







# Wood-aluminium windows

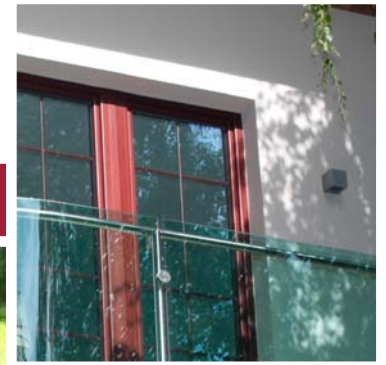

For customers who prefer the aesthetics of wood, yet require lower maintenance, we offer our wooden-aluminium **Alutrend** system. Their design incorporates, naturally beautiful wood from the inside and highly durable aluminium from the outside.

Alutrend system are available in an even wider range of colours and variety of aesthetic external profile finishes. We can supply various types of timber including pine, meranti, sapeli and oak, coated with transparent paint (with visible wood structure) or non-transparent finishes. Aluminium cladding (on the outside of the windows) can be painted uniformly in RAL colours or with a special technique imitating a wood grain finish (Decoral).

Alutrend windows can be produced in various shapes and depths (standard option, XL, Qube).





# Alutrend Classic

Wood-aluminium windows



depth  
83,5 mm  
(XL-93,5)



double glazed  
units  
(XL-triple)



burglar  
resistance



softline internal  
finish  
(modern angular  
finish - Qube)



simple shape  
of aluminium  
cladding



thermal  
insulation



microventilation



durability



high  
quality





# Alutrend Linear

Wood-aluminium windows



depth  
77,9 mm  
(XL-87,9)



double glazed  
units  
(XL-triple)



burglar  
resistance



softline internal  
finish  
**(modern angular  
finish - Qube)**



modern, flush  
aluminium  
cladding



thermal  
insulation



microventilation



durability



high  
quality





# Alutrend Softline

Wood - aluminium windows



depth  
87 mm  
(XL-97)



double  
glazed units  
(XL- triple)



burglar  
resistance



softline internal  
finish  
**(modern angular  
finish - Qube)**



rounded  
aluminium  
cladding



thermal  
insulation



microventilation



durability



high  
quality







# Alutrend Retro

Wood-aluminium windows



depth  
83,5 mm  
(XL-93,5)



double glazed  
units  
(XL-triple)



burglar  
resistance



softline internal  
finish  
**(modern angular  
finish - Qube)**



classic shape  
of aluminium  
cladding



thermal  
insulation



microventilation



durability



high  
quality















# Alutrend Synergic

Wood-aluminium windows



-  innovation: glazing covers the sash
-  depth 77,9 mm (XL-87,9)
-  triple glazed units
-  burglar resistance
-  softline internal finish (modern angular finish - Qube)
-  modern aluminium cladding
-  thermal insulation
-  microventilation
-  durability
-  high quality





# Alutrend Quadrat

Wood - aluminium windows



depth  
77,9 mm  
(XL-87,9)



double glazed  
units  
(XL-triple)



burglar  
resistance



softline internal  
finish  
(modern angular  
finish - Qube)



modern  
aluminium  
cladding



thermal  
insulation



microventilation



durability



high  
quality





# Alutrend Quadrat FB

Wood-aluminium windows



depth  
77,9 mm  
(XL-87,9)



triple glazed  
units



burglar  
resistance



softline internal  
finish  
(modern angular  
finish - Qube)



modern  
aluminium  
cladding



thermal  
insulation



microventilation



durability



high  
quality







# Alutrend Integral

Wood-aluminium windows



depth  
77,9 mm  
(XL-87,9 mm)



triple glazed  
units



burglar  
resistance



softline internal  
finish  
**(modern angular  
finish - Qube)**



modern  
aluminium  
cladding with  
a hidden sash



thermal  
insulation



microventilation



durability



high  
quality





# Alutrend Max

Wood-aluminium windows



depth  
107,5 mm



triple glazed  
units



burglar  
resistance



softline internal  
finish  
(modern angular  
finish - Qube)



modern  
aluminium  
cladding



thermal  
insulation



microventilation



durability



high  
quality



# Alutrend Miratherm

Wood-aluminium windows



high heat insulation  
**standard passive**



depth  
 126 mm



triple glazed  
 units



burglar  
 resistance



softline internal  
 finish  
 (modern angular  
 finish - Qube)



modern  
 aluminium  
 cladding



microventilation



durability



high  
 quality



# Colour schemes

Wood - aluminium windows

Alutrend windows from the inside are coated as per our timber systems.

The aluminium cladding from the outside can be powder coated in any standard RAL colour or in one of a range of more exclusive textured or wood effect finishes.



**Note!**

Colour palette for timber finishes - page 39.



# Aluminium windows

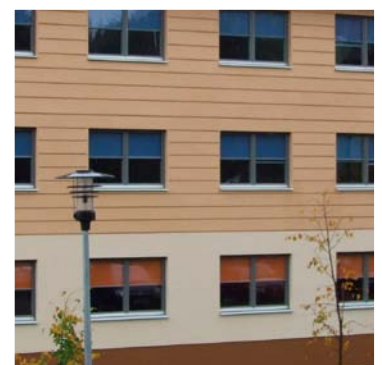
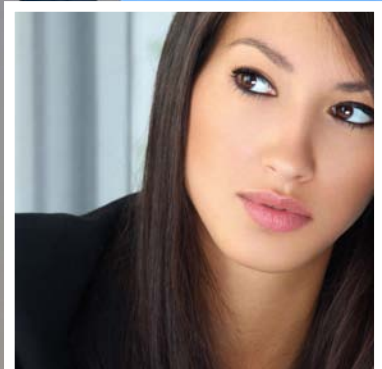
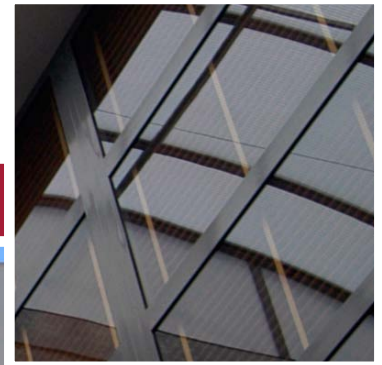

For clients who are looking for minimum maintenance and maximum durability we suggest aluminium window systems.

Aluminium systems provide the widest variation of solutions to cater for almost all residential, commercial and specialist situations. There are both non-insulated and thermally broken systems available. Thermally broken profiles come in a progressive range fulfilling even the most recent standards.



# MB-45

Aluminium windows

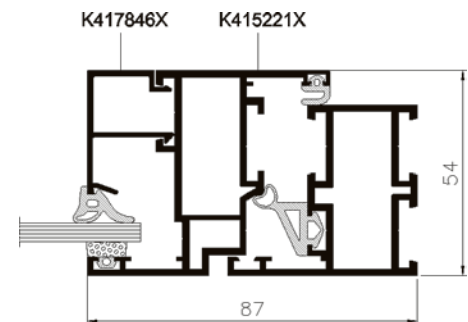

Specialist variant:  
**MB 45D** – system of smoke doors.



depth  
45 mm

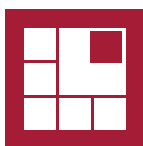

modern  
flush shape



durability



high  
quality





# MB-60

Aluminium windows



MB 60 HI



MB 60 E



MB 60 US

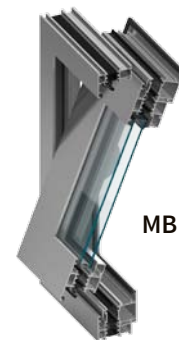

MB 60 Pivot

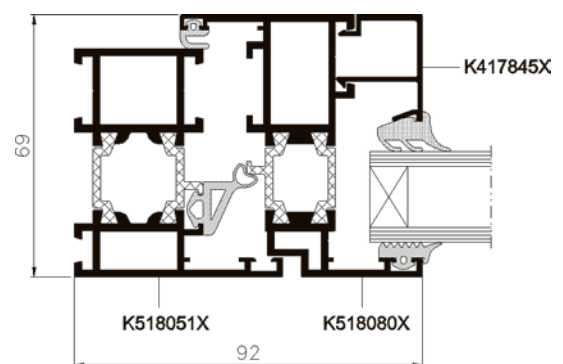

Windows MB 60 can also be presented in versions:

**MB 60 HI** – system of windows and doors with enhanced thermal insulation.

**MB 60 E** – economical variant.

**MB 60 US** – system with hidden sash.

**MB 60 PIVOT** – system of pivot windows.



depth  
60 mm

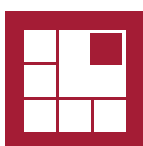

modern  
design



thermal  
insulation



acoustic  
insulation



microventilation



durability



high  
quality



# MB-70

Aluminium windows

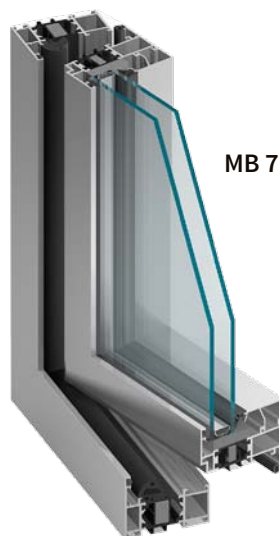

MB 70 HI

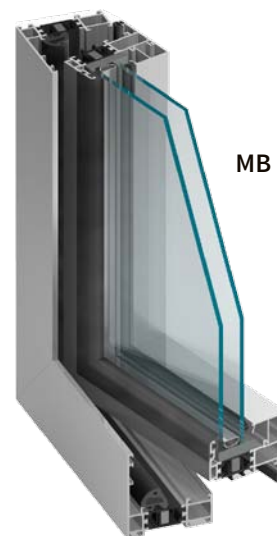

MB 86 US

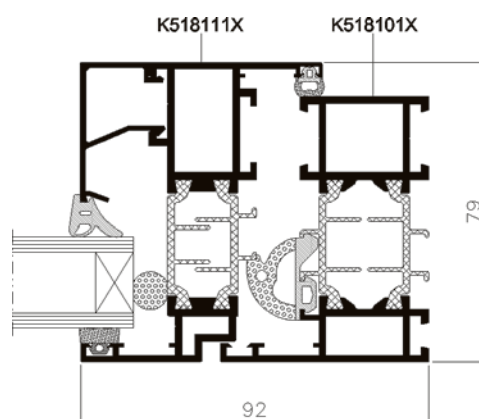

Windows MB 70 can also be presented in versions:

**MB 70 HI** – window - door system with enhanced thermal insulation.

**System MB 70 US** – window system with hidden sash.



depth  
70 mm

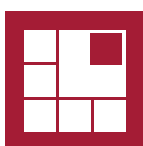

modern  
design



thermal  
insulation



acoustic  
insulation



microventilation



durability



high  
quality



# MB-86

Aluminium windows



MB 86 SI



MB 86 ST



MB 86 AERO

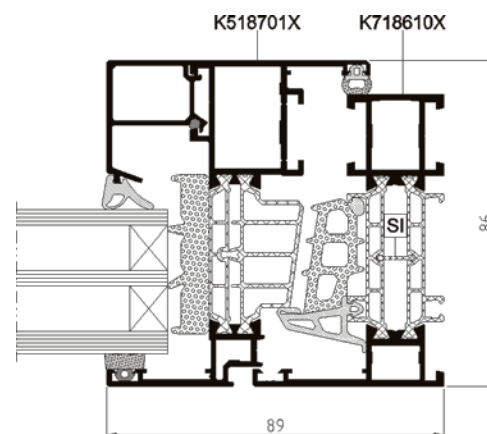

Windows MB 86 can also be presented in versions:

**MB 86 ST** – system of windows and doors with standard thermal insulation.

**MB 86 SI** – system of windows and doors with enhanced thermal insulation having an additional thermal break.

**MB 86 AERO** – system of windows and doors with further enhanced thermal insulation using airgel.



innovation



depth  
77 mm

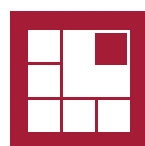

modern  
design



thermal  
insulation



acoustic  
insulation



durability



high  
quality



# MB-78 EI

Aluminium fire resistant constructions

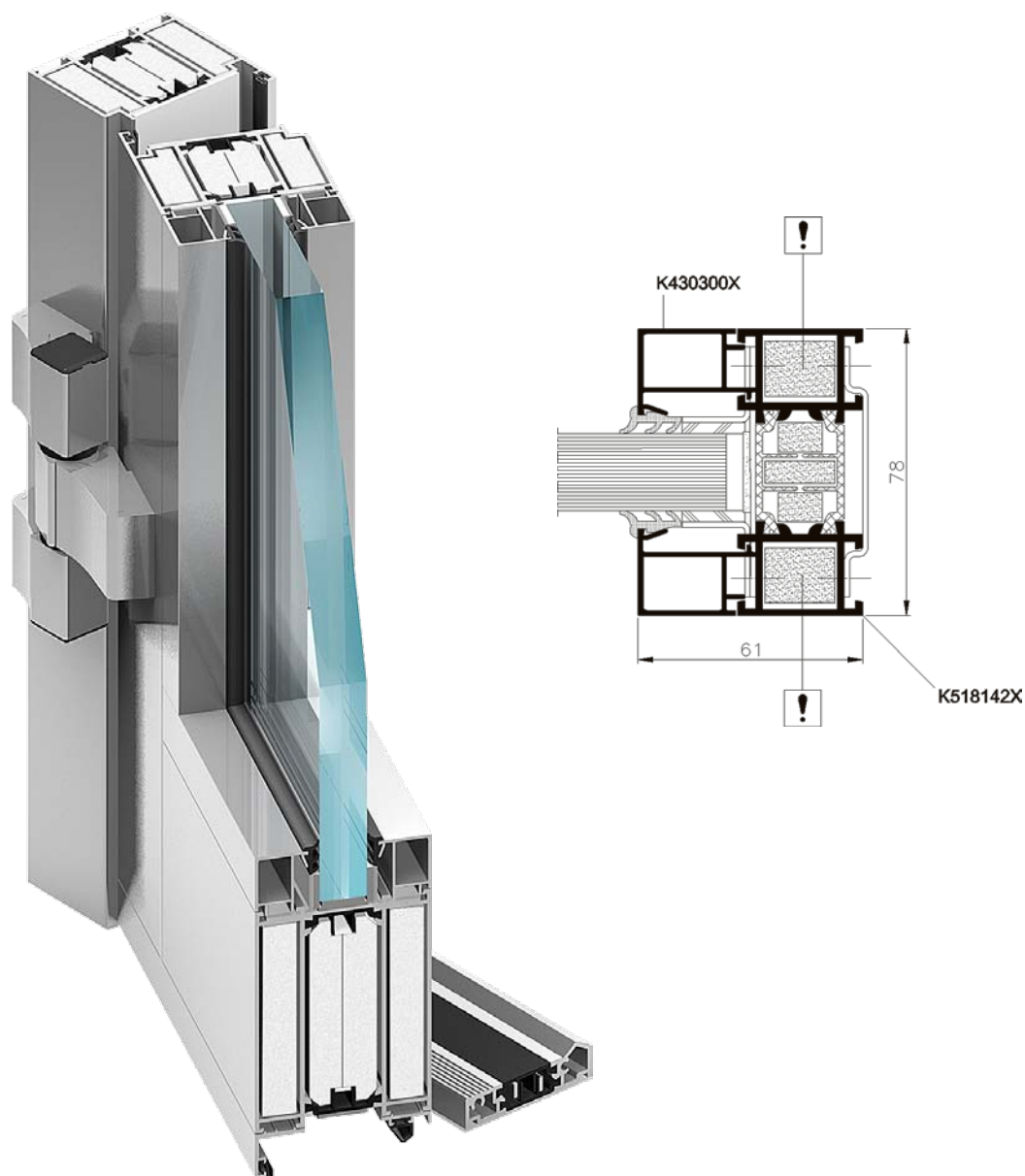

Possible variants of fire resistant fixed windows and doors:

- EI 30
- EI 60
- EI 90



innovation:  
fire resistance



depth  
78 mm

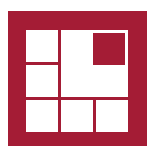

modern  
design



thermal  
insulation



acoustic  
insulation



microventilation



durability



high  
quality



# WICLINE 65 evo

Aluminium windows

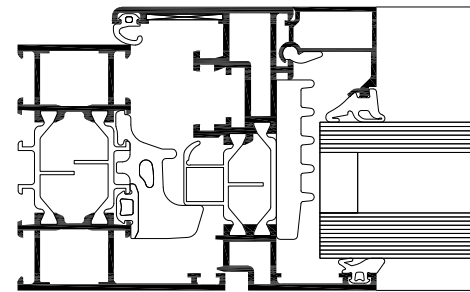

depth  
65 mm

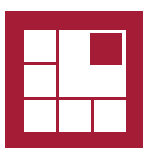

modern  
design



thermal  
insulation



acoustic  
insulation



microventilation



durability



high  
quality



# WICLINE 75 evo

Aluminium windows

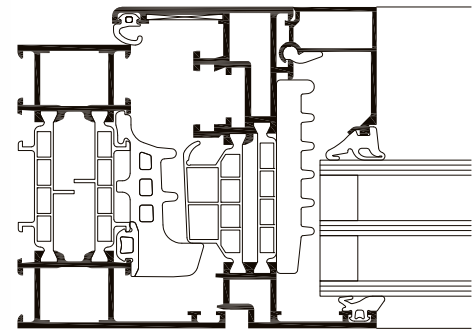

depth  
75 mm



modern  
design



thermal  
insulation



acoustic  
insulation



microventilation



durability



high  
quality



# WICSLIDE 23 - HST

Aluminium lifting sliding doors

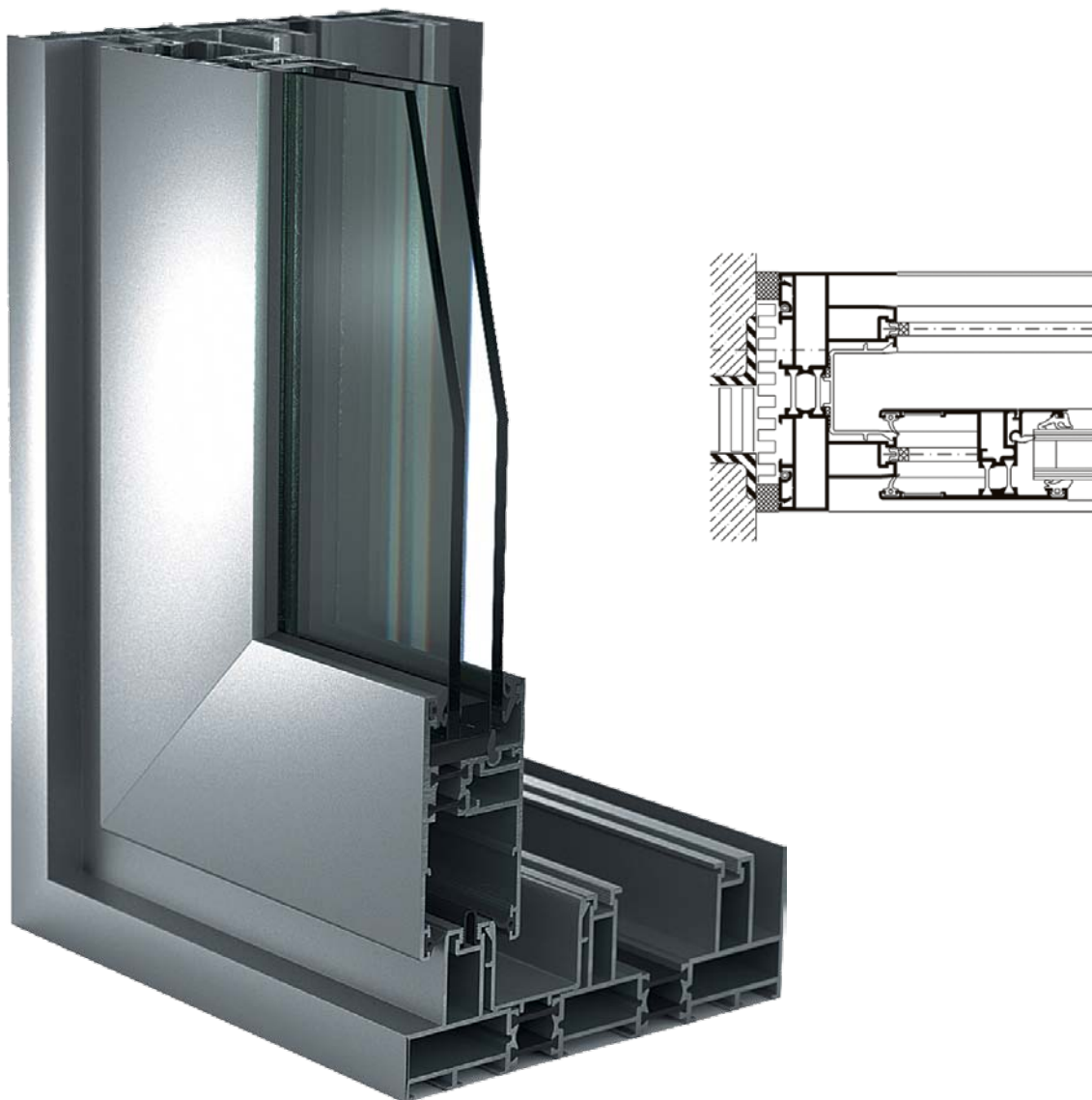

innovation:  
double or triple  
track lifting  
sliding doors

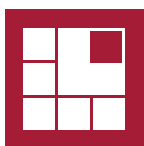

modern  
design



thermal  
insulation



acoustic  
insulation



durability



high  
quality



# HS77 (HI)

Aluminium lifting sliding doors

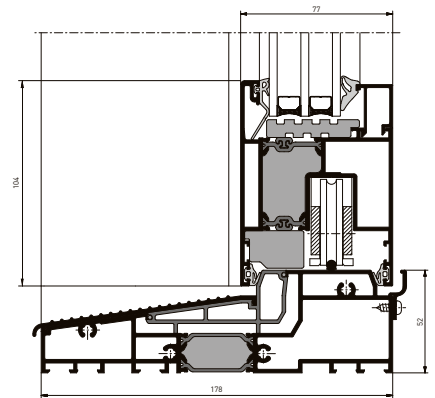
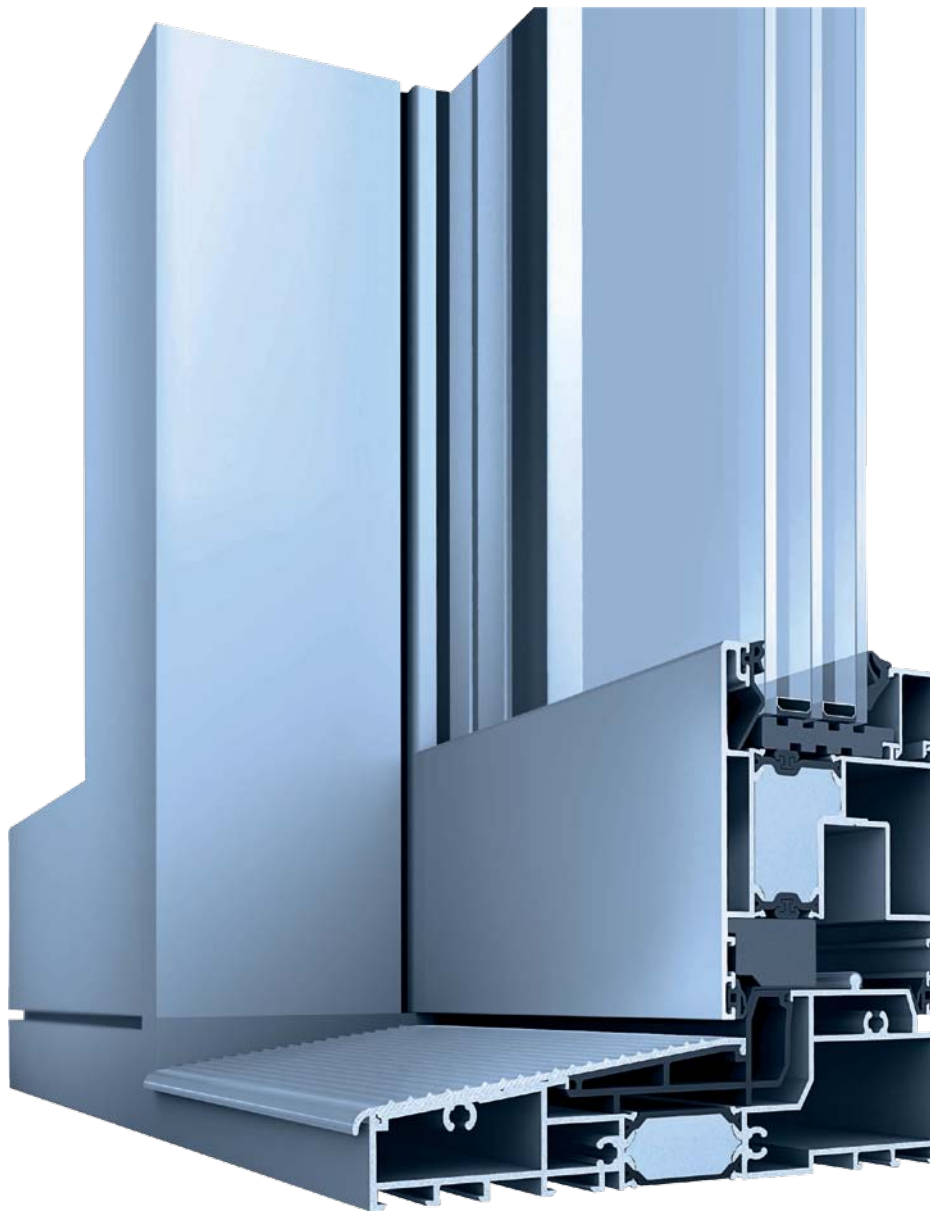

Source: heroyal-Johann Henkenjohann GmbH & Co. KG



innovation:  
 double or triple  
 track lifting  
 sliding doors

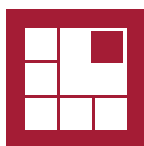

modern  
 design



thermal  
 insulation



acoustic  
 insulation



durability



high  
 quality





# WICSLIDE 65 FS

Aluminium folding doors

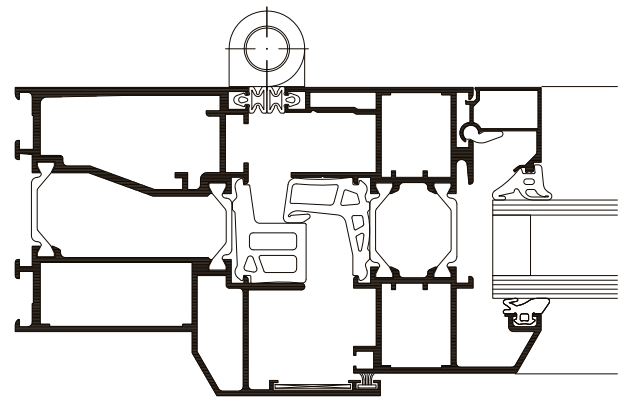
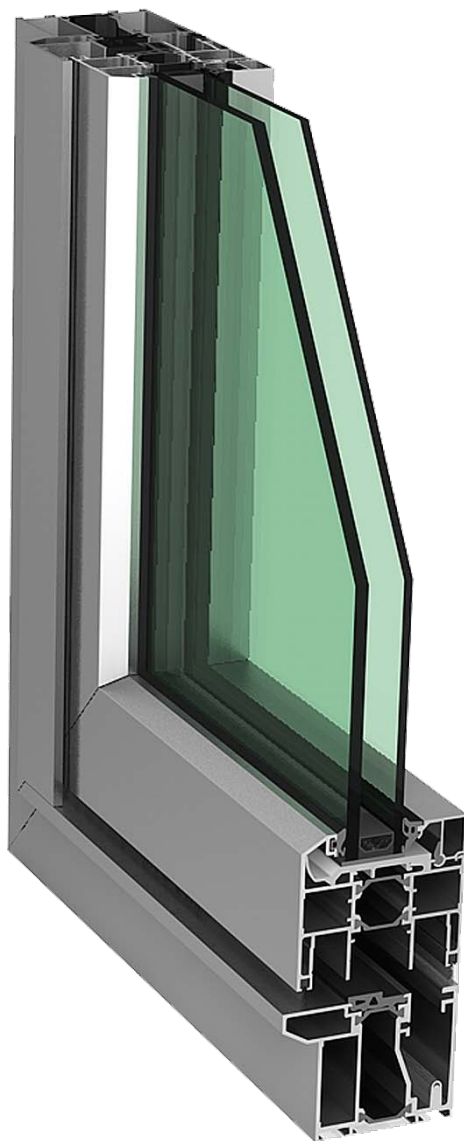

innovation:  
folding sliding  
doors

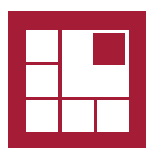

modern  
design



thermal  
insulation



acoustic  
insulation



durability



high  
quality



# MB – SLIDE

Aluminium sliding windows

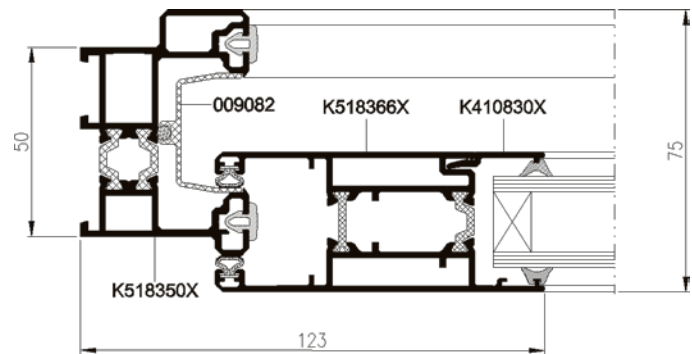

innovation:  
double or triple  
track sliding  
windows

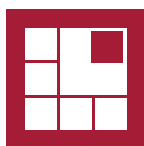

modern  
design



thermal  
insulation



acoustic  
insulation



durability



high  
quality



# Façades

Bertrand has good experience in construction of various façades of types ranging from pillar/transom to structural. In most cases we construct them using aluminium or combined WOOD-ALU profiles.

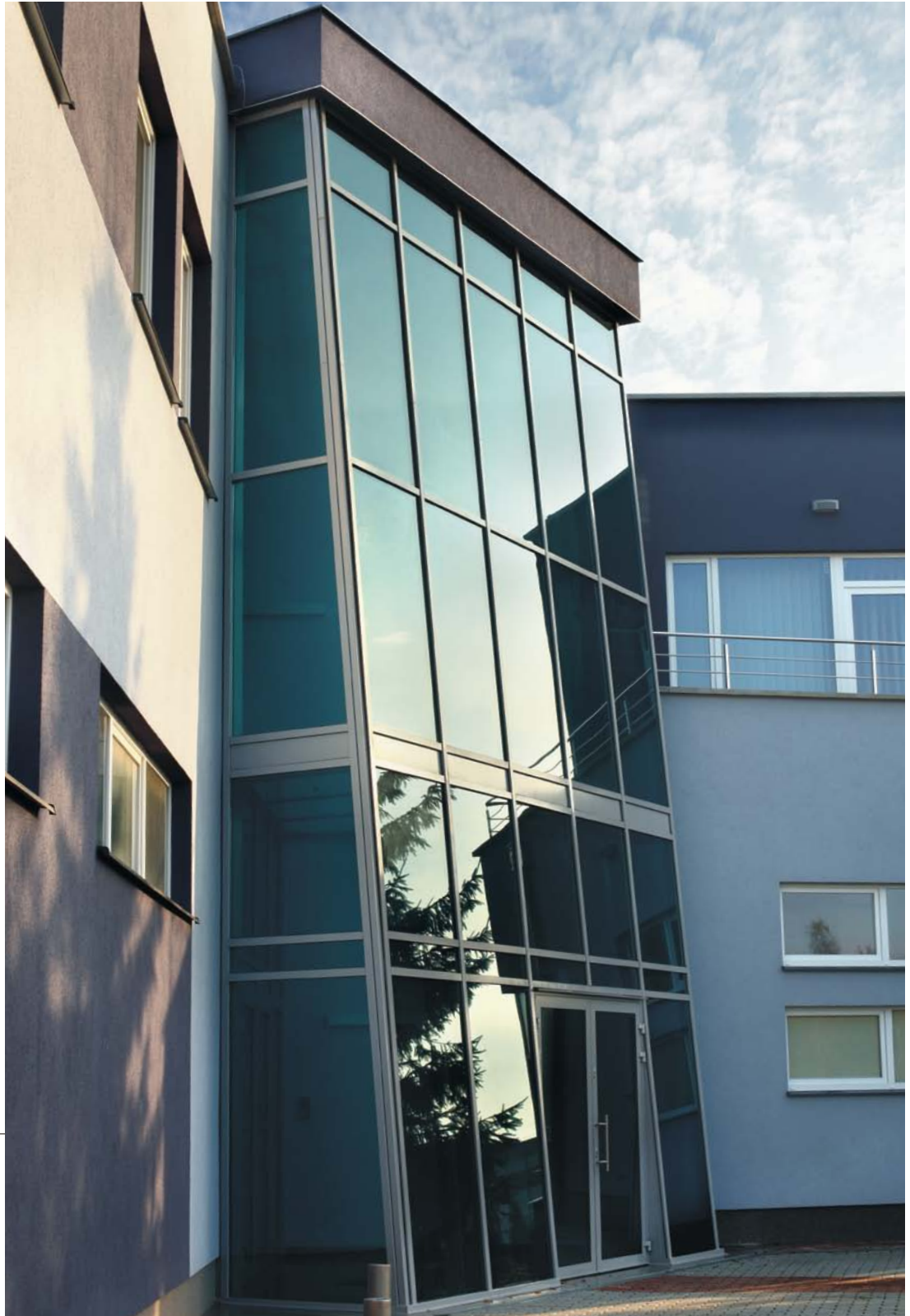





# SR 50 N

Aluminium façades

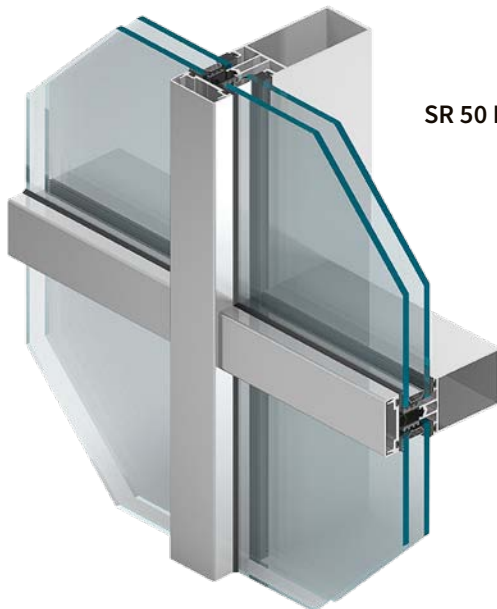

SR 50 N (HI)

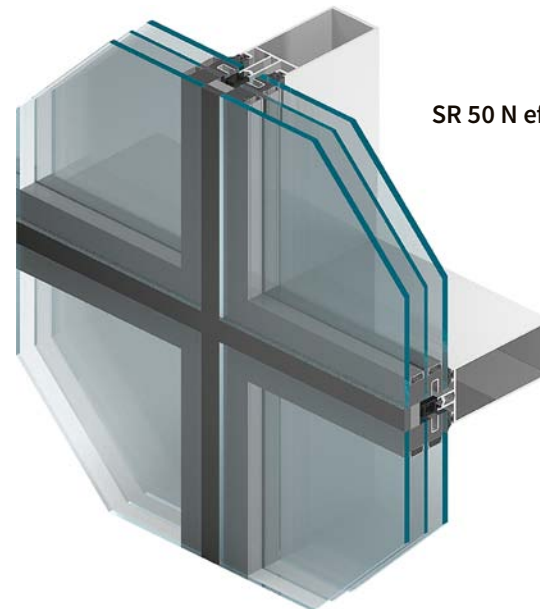

SR 50 N efekt

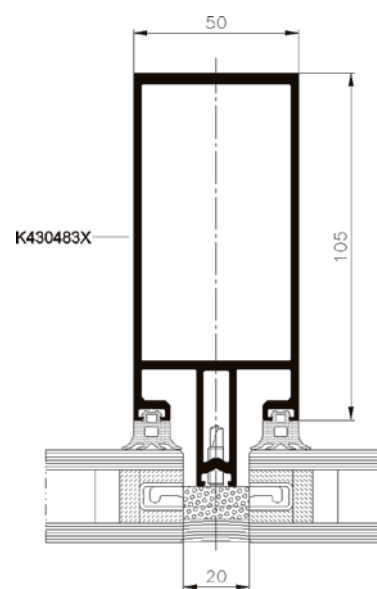
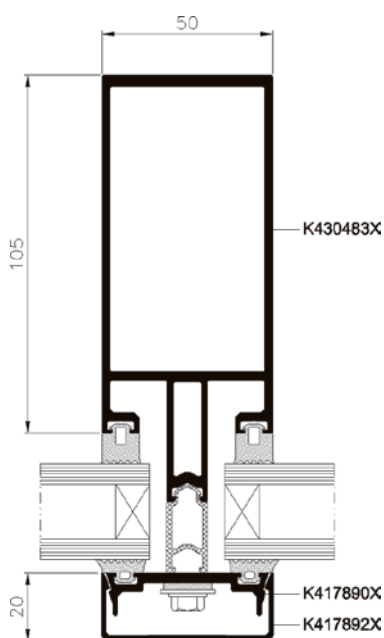

innovation:  
curtain  
walls and  
skylights

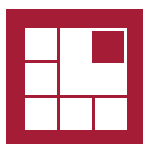

modern  
design



thermal  
insulation



acoustic  
insulation



durability



high  
quality



# Supplementary offer

## Shutters

Our offer includes a wide range of shutters in a variety of materials (timber, PVC, aluminium), applications (external, internal) and configurations (manual, motorised, folding, sliding).



## Roller Shutters

Bertrand windows can be equipped with any type of roller shutters both manually and electrically operated.



## Stained Glass

As an artistic form of window filling, stained glass gives a building exterior and interior a special character. You can place an order with Bertrand for any pattern of stained glass.

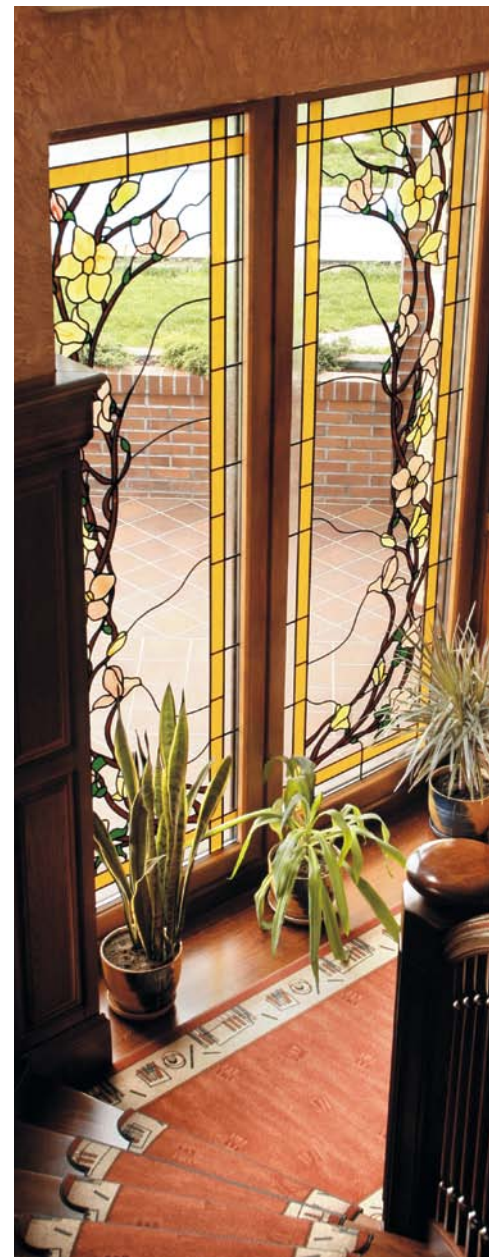

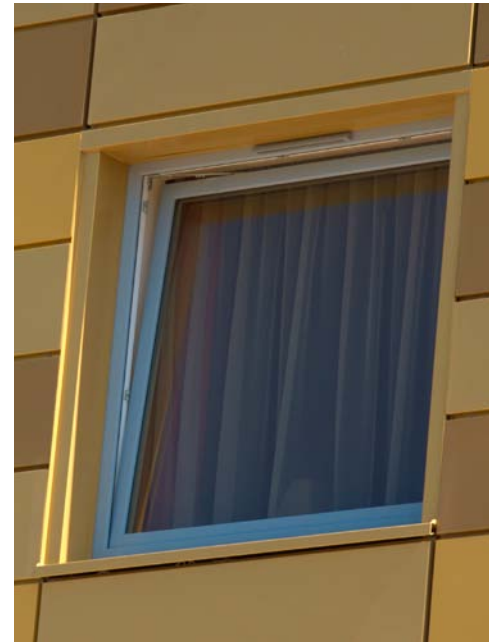

## Decorative elements

The decorative elements within our timber windows reveal the deep rooted craftsmanship passed down through generations of experienced carpenters who have been given the opportunity to realise their artistic ambitions at Bertrand. These carved elements blend seamlessly with the classic facade.

## Window sills

We have a wide selection of both internal and external window sills. We highly recommend our elegant timber sills crafted from solid timber and given precise attention to detail, available in an unlimited range of colours. We also offer a wider range of alternatives including interior sills of HDF, marble or conglomerate (stone pieces cast in a resin compound) and exterior sills of aluminium, steel or synthetic marble.

## Ventilators

Our product range also includes a wide selection of ventilators applicable to both residential and public spaces.







# Front doors

Bertrand offers wooden, PVC and aluminium doors. We have a wide range of designs, technical arrangements and extras determining aesthetic appearance as well as safety and usage comfort.

Sturdy doors made of solid wood ensure great appearance and safety. Their timeless beauty is a result of sound manufacturing procedures as well as our joiners' meticulous craftsmanship proven for many years.

Our aluminium front doors are modern, user-friendly and exceptionally weather resistant. They can be either painted in solid colours or finished with woodgrain foil which gives them the appearance of genuine wooden doors.







# Interior doors

Wooden interior doors made by Bertrand look elegant, are functional and very durable so their purchase is an excellent investment for a number of generations. We also offer interior doors in aluminium.







# Conservatories

A conservatory enhances the architectural qualities of a building and can completely re-vitalise its appearance. The conservatory space is a perfect place for relaxing all year round. Bertrand uses systems of sophisticated profiles designed for conservatories which give the structure a tasteful appearance and makes it air/water tight, stable and user-friendly.

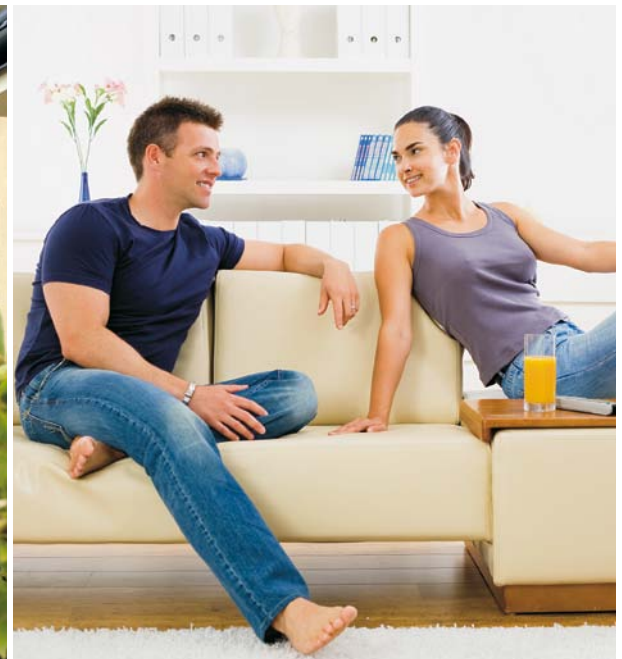



## Sliding doors and folding doors

Sliding doors and folding doors are a perfect means of creating the effect of space and wide passage. They may be even a dozen or so metres in width.



## Glass doors

Full glass doors are one of Bertrand's best sellers. Their modern design appeals to more and more clients. We utilise only the highest quality stainless steel components and toughened safety glazing. Glass doors come in variants both with and without frames.



## Woodwork for historical monuments

Bertrand is capable of fabrication of windows and doors which perfectly match the style of a historical monument and also meet specific requirements set by the conservation officer. New windows can have the same shape, division and glazing bars' layout as the original ones. It is also possible to replicate sculpted ornaments.





...you will understand the difference.

OFFICE

ul. Wejherowska 12  
84-242 Luzino, Poland  
tel.: +48 58 678 07 78  
fax: +48 58 678 07 79  
e-mail: info@bertrand.pl

EXPORT

tel.:  +48 58 678 07 74  
 +48 58 678 07 71  
 +48 58 678 07 74  
 +48 58 678 07 98  
 +48 58 678 07 66  
fax: +48 58 678 07 70  
e-mail: export@bertrand.pl



[www.bertrand.pl](http://www.bertrand.pl)

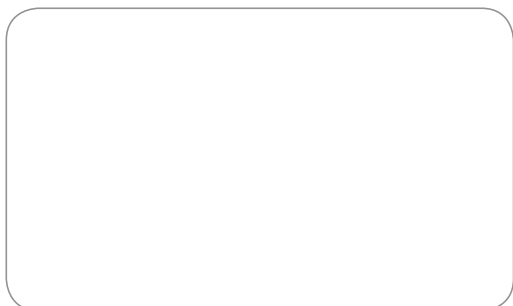

Project part - finance by the European Union.  
European Regional Development Fund.